

INSTALLATION GUIDE

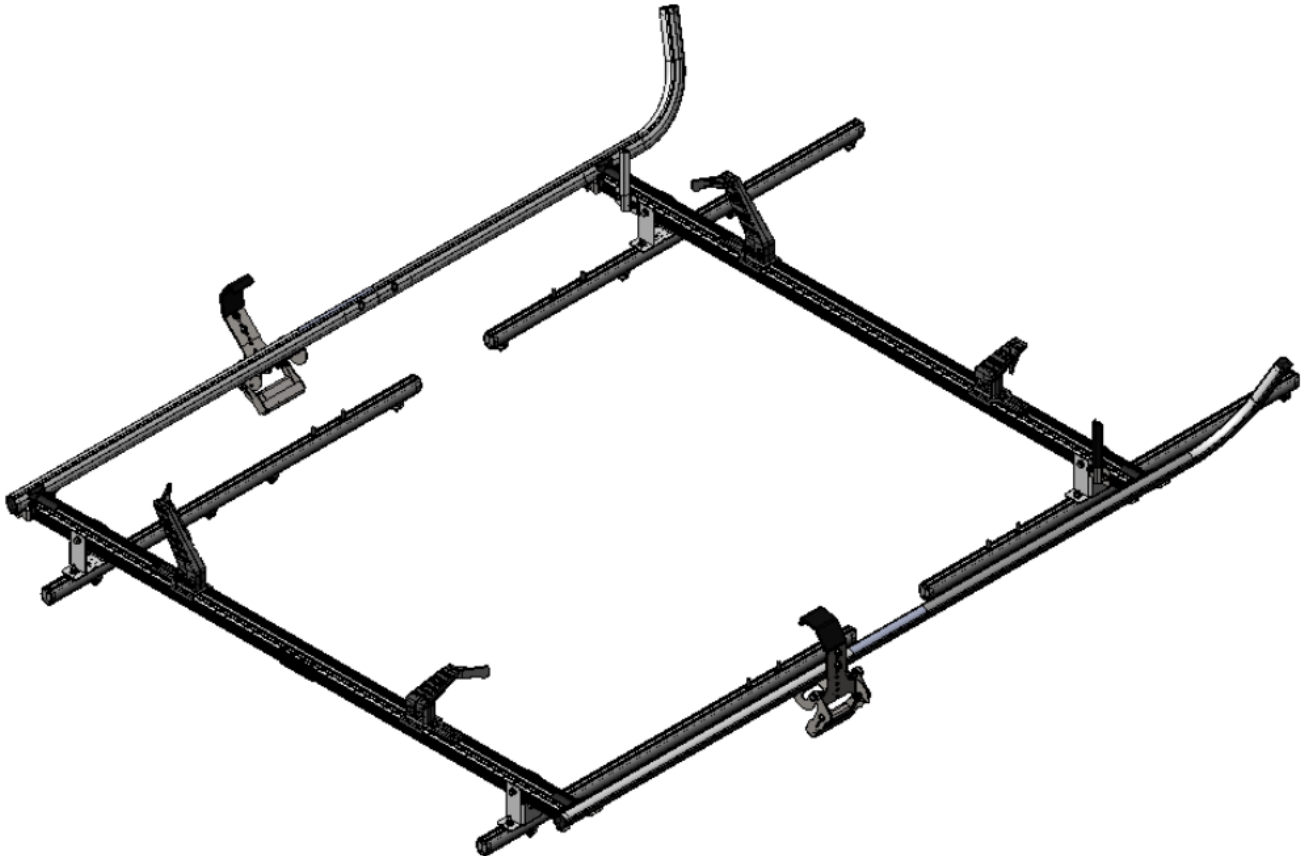

CLAMP RACK

1630-FTL,	1630-FTL3,	1630-FTR,	1630-FTR3
1630-GS,	1630-GS3,	1630-PHL,	1630-PHL3
1630-MM,	1630-MM3,	1630-PHM,	1630-PHM3
1630-PHS,	1630-PHS3,	1630-PHX,	1630-PHX3
1630-DH,	1630-DH3		



RANGER
DESIGN

ORDER OF OPERATION

CLAMP RACK



 **Click on this icon next to each unit to be redirected to the respective Install Guides.**

STEP 1

16-UCD72  16-UCDGS (for Savana)  16-UCD66 (for Metris) 



STEP 2

16-UCS72  16-UCSGS (for Savana)  16-UCS66 (for Metris) 



STEP 3a





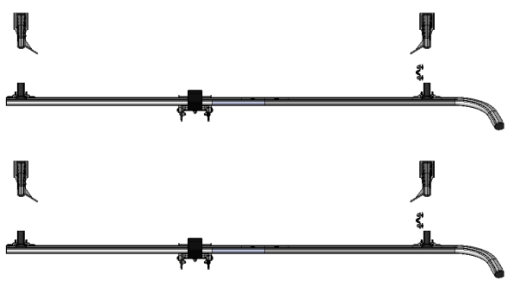





STEP 3b

16-UCL77 



STEP 4



FORD			MERCEDES-BENZ	
TRANSIT 130"	18-U0042		SPRINTER	18-U0018 
TRANSIT 148"	18-U0030		SPRINTER w/OEM Tracks	18-U0019 
			METRIS	18-U0043 
RAM			*Universal Bolt-Through foot Mounts	18-U0047 
PROMASTER 118"	18-U0020			
PROMASTER 136"	18-U0022			
PROMASTER 159"	18-U0032			
PROMASTER 159" Ext.	18-U0034			

*For 18-U0047: 1 kit per crossbar required.