

# INSTALLATION GUIDE



## CLAMP RACK

1625-DH,    1625-GS  
1625-FTR,   1625-FTL  
1625-MM,    1625-PHL  
1625-PHM,   1625-PHS  
1625-PHX



**RANGER**  
DESIGN

# ORDER OF OPERATION

## CLAMP RACK

 **Click on this icon next to each unit to be redirected to the respective Install Guides.**

**STEP 1**

16-UCD72  16-UCDGS (for Savana)  16-UCD66 (for Metris) 



**STEP 2**

16-UCL77 







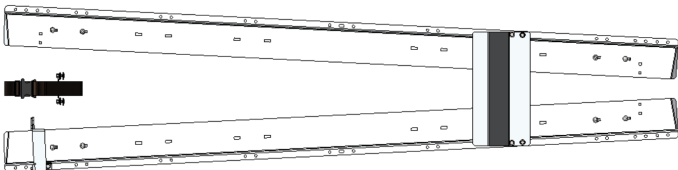





**STEP 3**

16-U1127 



**STEP 4**



FORD		MERCEDES-BENZ	
TRANSIT 130"	18-U0042 	SPRINTER	18-U0018 
TRANSIT 148"	18-U0030 	SPRINTER w/OEM Tracks	18-U0019 
		METRIS	18-U0043 
		<b>*Universal Bolt-Through foot Mounts</b>	18-U0047 
<b>RAM</b>			
PROMASTER 118"	18-U0020 		
PROMASTER 136"	18-U0022 		
PROMASTER 159"	18-U0032 		
PROMASTER 159" Ext.	18-U0034 		

\*For 18-U0047: 1 kit per crossbar required.