

INSTALLATION GUIDE

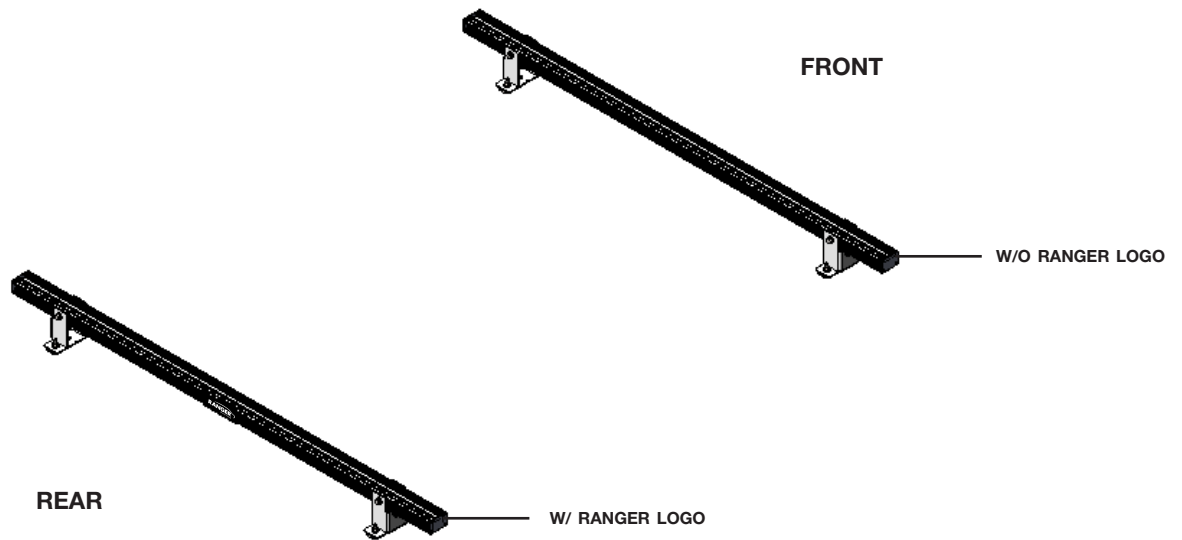

16-UCD66 Crossbar

2 BARS (66")



Scan the QR code for the latest Install-Guide.





BEFORE YOU BEGIN

READ, UNDERSTAND, AND FOLLOW ALL WARNINGS AND INSTRUCTIONS BEFORE USING THIS PRODUCT. FAILURE TO FOLLOW THESE DIRECTIONS MAY RESULT IN PROPERTY DAMAGE, SERIOUS BODILY INJURY, AND/OR DEATH. RANGER DESIGN IS NOT RESPONSIBLE FOR ANY PROPERTY DAMAGE, PERSONAL INJURY, OR DEATH THAT OCCURRED WHILE USING ANY RANGER DESIGN PRODUCTS.



WARNING

- Failure to use Ranger Design-provided fasteners, brackets, and proper installation guidelines could increase risk of serious personal injury and/or death.
- If drilling is required to complete this installation: improper drilling can cause property damage to vehicles and could lead to electric shock, fire, or even death.
- If drilling is required to complete this installation: Ensure that drilling is only performed on areas of the vehicle allowed by the vehicle's Original Equipment Manufacturer's Body Builders Layout Book (or equivalent document).
- Prior to installation, inspect the vehicle to ensure that installation will not interfere with, or cause obstruction of, any critical components such as electrical wiring, fuel tanks, fuel-cells, locks, latches, etc.
- The installer or manufacturer is responsible for ensuring anchorages are installed onto suitable wall and floor structures; wall and floor strength must meet applicable performance requirements.
- Do not install systems into any weak or unsound materials such as plastics, woods, thin-walled metals, etc. without proper reinforcement.
- Do not install this product where it could interfere with the deployment of airbags. Failure to comply could result in death or serious injury.
- Incorrect installation could cause water leaks, electric shock or fire.
- Any cargo vehicle with any cargo or equipment should use a certified partition. See Ranger Design website for some partition options. (<https://rangerdesign.com/>)
- Mountings rails are recommended for any attachment to the vehicle walls.
- All items in the cargo area should be properly secured and partition doors closed while the vehicle is in motion.
- Check your vehicle's tare weight and remaining load capacity with all the equipment installed. Never exceed the maximum Gross Vehicle Weight Rating (GVWR), Gross Axle Weight Ratings (GAWRs), or other maximum loads permitted by the vehicle's Original Equipment Manufacturer (OEM) and required by law.
- The heaviest items must be placed towards the bottom of the vehicle, while the lightest ones can be arranged upwards. Vehicle cargo loading weight proportion should follow the following guidelines:

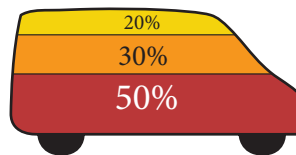

- The final alterer and/ or modifier should review the warning sheet with the customer before the vehicle is released to the customer or for general use. These instructions should remain with the vehicles a all times.
- Any modification or unintended use of this product voids any warranty and could create a hazardous condition.
- Ranger Design provides recommended assembly and installation instructions which should be followed to ensure correct operation. Failure to do so could result in invalidating the product's compliance, warranty and cause injury. Notwithstanding, the final stage vehicle alterer and/or modifier is responsible for the integration, installation, and compliance of the product in its final location to all applicable regulations and standards. Failure to maintain compliance of the vehicle to applicable regulations and standards could be punishable by law. Alterers and/or modifiers should consult with all local authorities prior to commissioning.



CAUTION

- If drilling is required to complete this installation. Before drilling, ensure that you will not hit any critical parts of the vehicle like the gas tank, wiring harness, or hose. Consult the vehicle OEM documentation as necessary. When drilling, use a drill collar to reduce the risk of damage to the vehicle.
- Any materials, padding, or glazing installed in the vehicle must comply with FMVSS/CMVSS 201/205/302, as applicable.
- In the event of a motor vehicle accident or collision where a Ranger Design system has been installed, especially ones where the vehicle structure is damaged and/or the air bags deploy and/or the vehicle has been towed, the system must be inspected to ensure continued soundness and safety before returning the vehicle to service. Damaged components should be replaced as necessary.
- All system components should be regularly inspected, cleaned, and maintained pursuant to Ranger guidelines.

QUICKSTART GUIDE

Phase 1 - Assembly

1.1 Setup..... 4

Phase 2 - Installation

2.1 Install..... 5

REQUIRED ITEMS

- Rubber Mallet
- Ratchet
- Socket 1/2"
- Anti-Seize

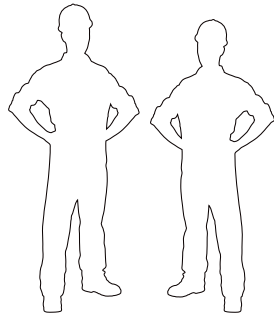

2
PERSONS

PHASE 1 – ASSEMBLY

1.1 SETUP

1.1.1 Verify all parts are present.

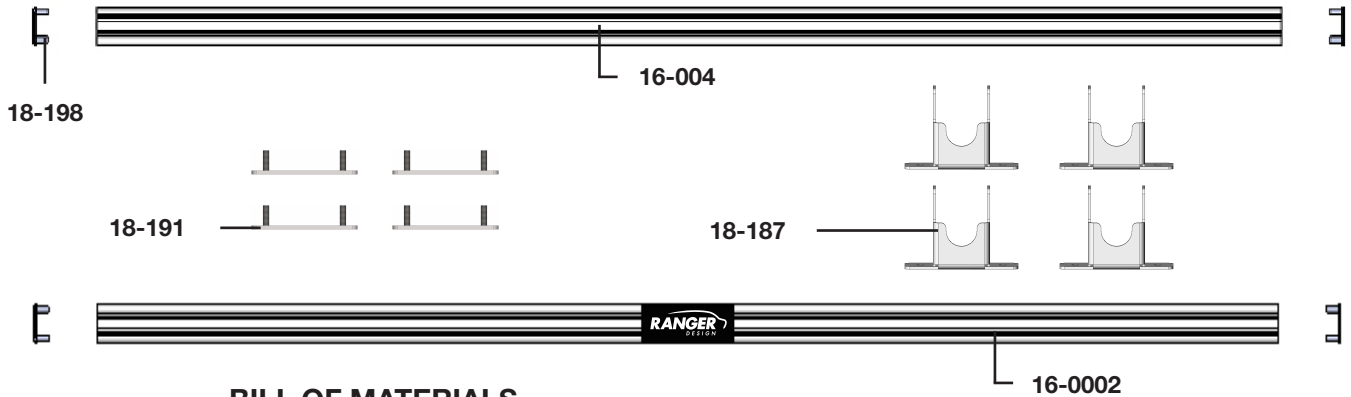

BILL OF MATERIALS

Item No.	Description	Qty.
18-187	Foot	4
16-004	Crossbar 66"	1
18-198	End Plastic Plug	4
18-191	Stud Plate	4
79-927	Warning Label - English	1
79-928	Warning Label - Bilingual	1
79-954	Small Label, Max Height, Ladder Rack	1
16-0002	Crossbar 66" w/ Ranger Logo	1
94-1806	Fastener kit	1



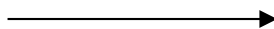

VERIFY ALL PARTS ARE PRESENT

FASTENER BAGS.





94-







Fastener Assembly

- 8x  # 90-203 Bolt hx-hd 5/16" -18x5/8" SS304
- 8x  # 94-105 Hex Nut 5/16" SS316 WAX
- 8x  # 94-250 NUT - CHANNEL, 5/16"-18 SST
-  # 98-117 Flat Washer 5/16" OD, 3/4" SS18-8
-  # 98-123 Lock Washer 5/16" SS304

8x

-  #90-203 Hex Bolt 1 - 1/8"
-  #98-123 Lock Washer 5/16"
-  #98-117 Flat Washer 5/16"
-  #94-250 Channel Nut 5/16"

4x

-  #94-105 Hex Nut 5/16" (x2)
-  #98-123 Lock Washer 5/16" (x2)
-  #98-117 Flat Washer 5/16" (x2)
-  18-191

1.2 ASSEMBLY

Prior to following this step, please see the install guide of the mechanism being installed. If no additional steps are required proceed with this install guide.

1.2.1 Follow the table below to install the crossbars onto the feet.

TOOLS

- Ratchet
- 1/2" Socket

HARDWARE USED 8x (11 lbs • ft)

	#90-203 Hex Bolt	1 - 1/8"
	#98-123 Lock Washer	5/16"
	#98-117 Flat Washer	5/16"
	#94-250 Channel Nut	5/16"

FOOT PLACEMENT GUIDE	
VEHICLE	DIMENSION (A)
METRIS	4 - 5/8"
PROMASTER CITY	8 - 5/8"
TRANSIT CONNECT	8 - 1/4"

PHASE 2 – INSTALL

2.1 INSTALL

2.1.1 Fasten feet to mounting tracks.

NOTE: Follow the appropriate Ladder Rack mechanism IG or Mounting Track IG to install the crossbars in the correct position. The values may vary depending on Vehicle and Ladder

TOOLS

- Ratchet
- 1/2" Socket

HARDWARE USED 4x (11 lbs • ft)

	#94-105 Hex Nut	5/16" (x2)
	#98-123 Lock Washer	5/16" (x2)
	#98-117 Flat Washer	5/16" (x2)
	18-191	

NOTE: The 16-0002 Crossbar must be positioned at the rear, with the Ranger Logo facing the rear of the vehicle.

2.1.2 Install caps.

TOOLS

- Rubber Mallet **4x**

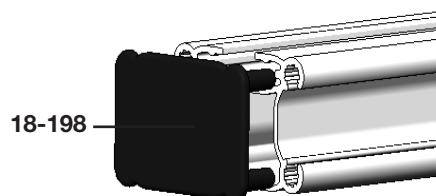

“You have successfully installed your Crossbars, thank you for doing business with us.”

For any feedback or suggestions, you may have, please contact: cs@rangerdesign.com